

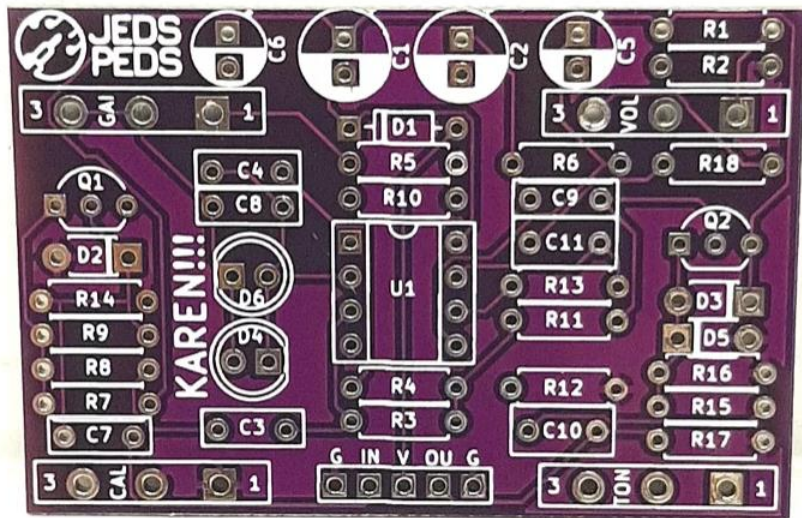

## Karen!!! - Pedal Kit



Please read the guide in full before starting your build. It contains a lot of really important information which will give you the best chance of a successful build.

For build support, please join our [Facebook Forum](#).

1. [Parts lists for this kit](#)
2. [Suggested Tools](#)
3. [A detailed overview of components](#)
4. [Populating the main PCB](#)
5. [Jacks and the Power Socket](#)
6. [The footswitch, its PCB and offboard wiring](#)

## Parts List – Main Circuit

<b>R1</b>	10K	<b>R16</b>	10K	<b>C1</b>	100U	<b>D1</b>	4001
<b>R2</b>	10K	<b>R17</b>	51K	<b>C2</b>	47U	<b>D2</b>	9V1
<b>R3</b>	100K	<b>R18</b>	1K	<b>C3</b>	100N	<b>D3&amp;5</b>	4148
<b>R4</b>	4K7			<b>C4</b>	100N	<b>D4&amp;6</b>	BLUE LED
<b>R5</b>	43K			<b>C5</b>	220N		
<b>R6</b>	10K			<b>C6</b>	220N		
<b>R7</b>	5K1			<b>C7</b>	100N	<b>U1</b>	TL072
<b>R8</b>	10K			<b>C8</b>	47P	<b>CAL</b>	5KC
<b>R9</b>	10M			<b>C9</b>	100N	<b>GAIN</b>	1MA
<b>R10</b>	810R			<b>C10</b>	1U	<b>TONE</b>	20KW / B
<b>R11</b>	510K			<b>C11</b>	1U	<b>VOL</b>	100KA
<b>R12</b>	100R						
<b>R13</b>	1K					<b>Q1</b>	BS170
<b>R14</b>	10M					<b>Q2</b>	2N3904
<b>R15</b>	1K						

## Offboard Components

3PDT footswitch	
Wire	
LED	Coloured
Mono Jacks x2	
Power Socket 2.1mm	
3PDT Footswitch PCB	Supplied when stocked

Please check the kit against the parts list upon receipt, I hand pick kits to order and I am only human.

I appreciate the photograph of my build is clear-ish, but I advise against simply copying it to yours as components change appearance regularly. Please work from the parts list to avoid error.

Some values may be substituted for as near as, there will be little to no difference if you sub a resistor or capacitor but if you have received a different chip or transistor than shown and cannot establish if it is an intentional sub, please contact us. A good search term for this would be "is xxxx an appropriate substitute for xxxx"

### Suggested Tools

<b>Essential</b>	<b>Desirable</b>
Soldering station	
Solder - 60/40 or good quality lead free	
Wire snipping pliers	
Wire stripping pliers	
Solder sucker / de solder braid	
PCB Clamp	
Multi Meter	
	Centre Punch
	Drill bits
	Tweezers

The essential tools are all the bare minimum of what I use to build a pedal. The list is not exhaustive, but we do get a lot of enquiries about what tools people need.

[I sell a large range of pedal building related tools here.](#)

# Schematic

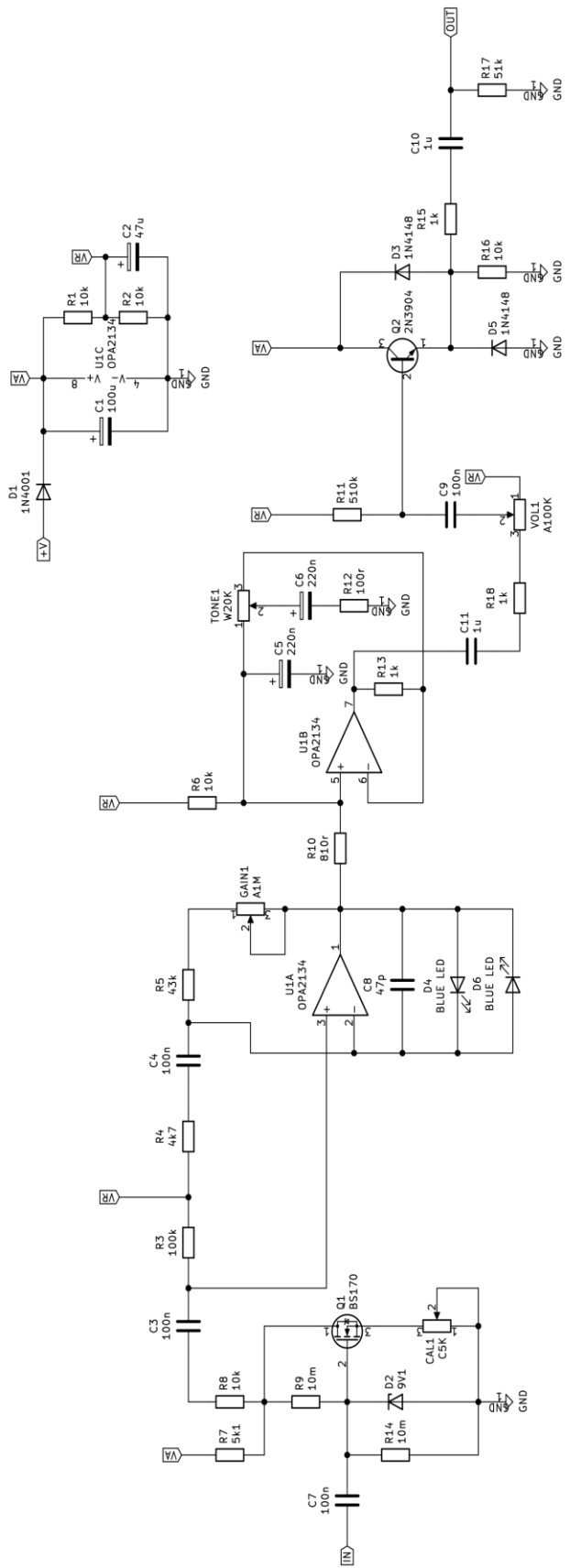

jedspeds.co.uk

**Jeds Peds**

Sheet: /

File: Report Card.sch

**Title: Report Card**

Size: A4 Date: 2021-09-06

KiCad E.D.A. kicad (5:1.6-0-10:14)

**Rev: V1.4J**

Id: 1/1

## A Detailed Overview of the Components in this Kit

### Resistors

If we use the analogy of water rather than electricity, then resistors would be called restrictors. They restrict the flow. Resistors are non-polarised (they can be inserted either way round). The body of a resistor can be one of many colours. Most commonly seen in our kits are blue or buff.

What really matters is the colour of the bands around the body. There may be 4 or 5 of these. on a 4 band resistor the first two colours give you the value for the resistor and the 3rd gives you the number of zeros to add (aka the multiplier). With a 5 band resistor the first three give you the value and the 4th gives you the zeros. See the table below.

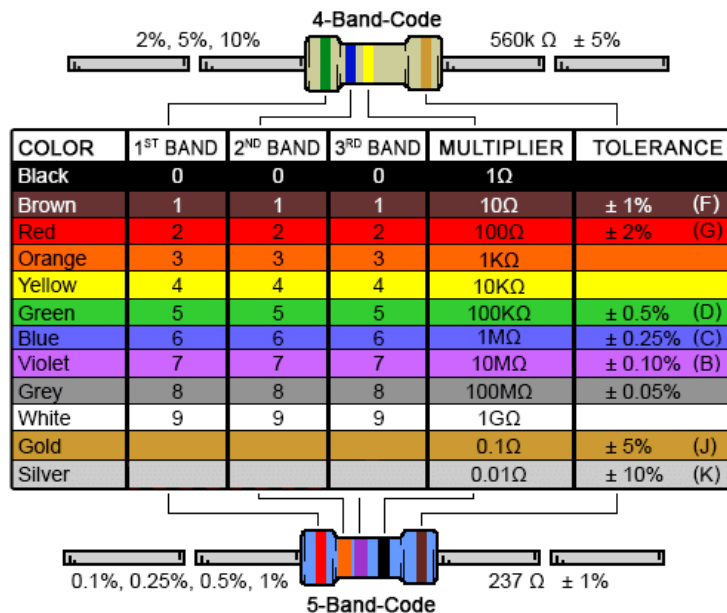

So the 4 band resistor above that has rings of green, blue, yellow and gold is a 560000 $\Omega$  (or 560k $\Omega$ ). You will see this 'value plus zeros' reappear when we get to capacitors. Note that a 4.7k $\Omega$  resistor would normally be written by me as 4k7.

Note that if the multiplier is gold or silver you divide the leading figures by 10 or 100.

You can either decode them yourself following the above table, alternatively this [online resistor calculator](#) or you can use a multi meter. If you want any further explanation about how to decode resistor values, [this video](#) may help.

There's also a lovely table below to use as a starting point. *NB, whilst most values I use are shown there is a chance not all will be.*



# RESISTOR GUIDE

1%		5%		1%		5%		1%		5%	
10r			1k8			20k			270k		
33r			2k			22k			330k		
47r			2k2			27k			360k		
68r			2k7			30k			390k		
130r			3k			33k			430k		
150r			3k3			39k			470k		
180r			3k6			47k			510k		
220r			3k9			51k			560k		
330r			4k7			56k			680k		
390r			5k1			62k			750k		
470r			5k6			68k			820k		
510r			6k2			82k			910k		
560r			6k8			100k			1m		
680r			7k5			130k			1m5		
820r			8k2			150k			2m2		
1k			10k			180k			3m3		
1k2			12k			200k			3m9		
1k5			15k			220k			4m7		
			18k			240k			10m		

1% resistors tend to have blue bodies.

5% buff.

## Diodes

Again, going back to the water analogy, diodes can be thought of as one-way valves. They allow electricity to flow in only one direction. The electrical symbol for a diode is shown below. They must be inserted in the correct direction for the circuit to work.



The anode is the positive end and the cathode is the negative. electricity will only flow from the anode to the cathode. Diodes can be various colours but usually have one or sometimes two bands at one end.

The symbol on the PCB will be something like this, simply line up the band on the diode with the line on the board.

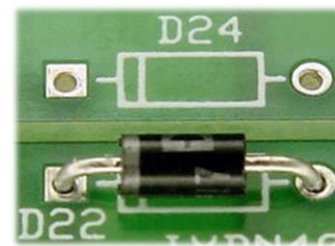

The diodes in this kit should look like this;



1N4148



1N4001

They are fragile, so be careful when you bend the legs.

Diodes, like all silicon components, are heat sensitive. When soldering, limit the contact time as much as possible. Aim for a maximum of 4 seconds. Less is good! If you have more than one diode to solder it is good practice to do one leg on each then go back for the second. This way the diode has time to cool between each leg being soldered.



## LED's

These perform like other diodes except that they glow when a current passes through them.

Their position on the PCB will be shown like this

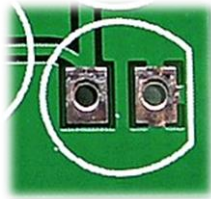

The LED will also have a flat side.



Generally, the rule would be to match the two and most of the time that is what you will do. However, to save you the soldering your LED's I recommend testing them with a multi meter (set to diode test mode) to be 100% sure you are connecting the positive side where it needs to be. On the example above the positive feed goes into the round side.

I have come across LED's orientated opposite to what I expected previously, after installation... so this quick test is sensible and is one less thing to debug later on. Check twice...solder once.

## Transistors

This kit comes with transistors

The body of the transistor is usually a small black 'can' with a flat on one side.



The shape on the PCB corresponds to the 'can'

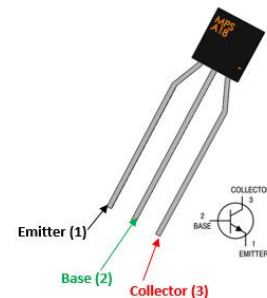

The transistor can be the one listed or any other suitable substitute with matching pin out. The orientation of this part is crucial. The silkscreen layer indicates which way around it needs to be with its transistor shaped outline, matching the transistors case. Solder this **very** carefully.

**The same warning about heat when soldering diodes also applies to transistors. Take your time not to overheat.**

## IC's aka 'chips'

IC's are small packages that contain many components. The ones that you will find in this kit will have 8 legs.

On the PCB pin 1 will be marked with a \* and there will be a small notch drawn on the footprint. The solder pad for pin 1 will be square. The socket will also have a notch. Be careful with the pins, they are fragile.

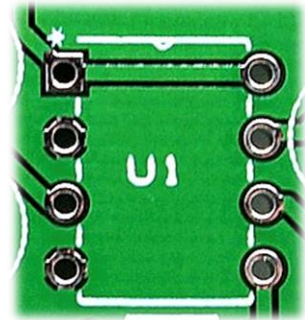

This is a socket. I do try to supply sockets for the chips, so unless I am out of stock you should have one per chip. Solder these in place without the chip, totally protecting the chip from heat. Please check you have all pins through the pads before you begin soldering the socket.

## Capacitors

Capacitors come in many shapes and sizes but fall into two basic camps. Polarised or non polarised. Capacitors can store energy. For a really good explanation of how they work try [this video](#) starting at 4:25.

This kit uses some non polarised capacitors. The good news is that just like resistors you can insert them into the PCB either way round.

Now the bad news. they come in a variety of shapes and sizes and although there are supposed to be standards for markings they do vary. So, what do they look like? This kit predominantly contains box caps, like this one.



Now, the marking. Capacitance is measured in Farads (f). 1f is a huge capacitor. Going down in order there are Millifarads, mf (rarely used) 1 mf is 1/1000th of 1f. Microfarads uf 1/1000th of 1mf. Nanofarads nf 1/1000th of 1uf and Picofarads 1/1000th of 1nf.

Another way to put it is that there are 1000pf in 1nf and 1000nf in 1uf.

Polyester box capacitors with values of 1nf but less than 100nf will have the value written on the top, either in a very obvious way, or a code.

The capacitor shown above has a value of 100nf. A 1uf capacitor would begin with 1\*\*\*, value of 1000, so with the additional decimal point, .1k is 100nf. The K is the tolerance (10%) and 63 is the max voltage. Manufacturers do have other ways of indicating values though unfortunately.

Where things can get difficult is with poly boxes of 100nf and above. sometimes you will see a 100nf marked as 104xxxx ie the picofarad notation has been used for the value. Equally you may see .1xxxx ie 0.1uf (the x's denote the tolerance and voltage). It is still the same 100nf capacitor. The reason for this is that only 3 digits can be used for the value so 100n cannot be used and 100 would denote 100pf. Still with me? this continues for high values until we get to 1uf which will be marked as 1uxxxx.

Sometimes I supply 1UF MLCC style capacitors marked as 105. These are a small yellow bead. The different styles of non polarised caps are all interchangeable so do not worry if you expect a box cap and get a MLCC or vice versa.

Eventually these capacitor and resistor codes will start to sink in! Trust me.

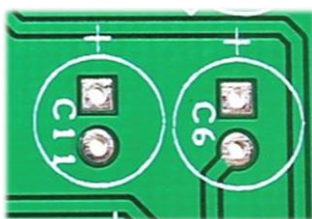

Now onto polarised, they are the simplest. The most common that you will see are 'electrolytic' capacitors. These look like a small beer can with two protruding wires, usually from the same end, sometimes one from each end. on the outside of the can will be the value and the max voltage. Polarised capacitors can only be inserted into the board in one direction. The PCB will have a + next to the positive terminal.

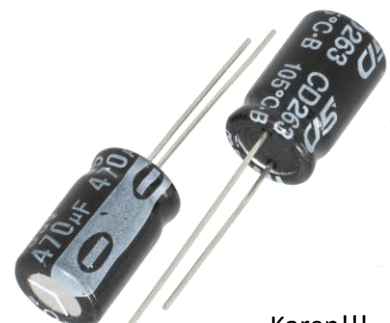

On the capacitor you will see that one side of the can is marked with a stripe usually containing negative symbols. The wire nearest to this is the negative wire. You will also notice that the positive wire is longer.

## So now it's time to get down to building your pedal!

We are hoping to go from this

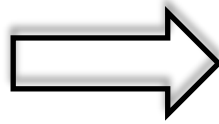

to this



The first thing you must do is identify your parts from the pack. I suggest you separate them into groups of like components, working on one smaller group at a time.

Start with the main PCB and set aside anything to do with the offboard section. You won't need to worry about that bit for a while yet.

As a rule, I build from small to big – therefore step one will be to identify the resistors and any diodes inside your kit.

Each kit has a parts list at the top of the guide. So as an example, if R1 is listed as a 1M resistor then you dig out a 1M from the pack and place it on the PCB in the R1 spot. It's your call if you put one in and solder or put a few in or even put them all in and solder. I'll let you decide.

The front of the PCB is the side with the white writing on (the silkscreen)

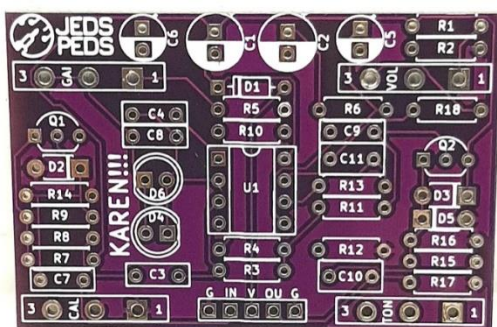

You then need to follow the same process for all the other parts. Working in height order mount the rest of the parts to the PCB ensuring that you solder them in place well as you go.

I then add the pots either mounting them to the board or wiring them into place.

## Pots

As a rule, I design my PCBs to accept two styles of potentiometer.



Usually if a kit is designed for this style then you will receive them.

*Occasionally* you may receive a mixture of this style and the next. If so, you can use wires to attach the pot to the PCB. There are various reasons this may happen such as supply issues or it may also be a part of the design.

If you received any pots that look like this, then they will need to be wired to the PCB. You can achieve this by using normal wire, or, you can use header pins which is what I did when I prototyped others.

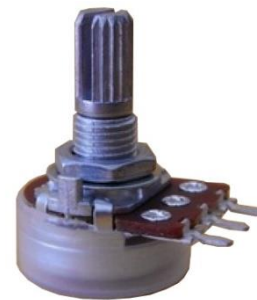

The pots have their values written on them

The pins are numbered, but that is not written on the part. Pin 1 is indicated on the PCB with either a square pad or a number 1, or both. The pin numbers are the same for both types of pot.

**Pin Numbers: 1 2 3**

Just behind pin 1 and next to the shaft is a small metal tag.

Take a pair of pliers and snap this off. It comes away easily.

Sometimes the pots have plastic covers on the bottom, like this one. Sometimes they don't. If the pots you receive don't have the dust cover, then you need to ensure you isolate the metal case of the pot from touching any other metal components, or it will cause you problems.



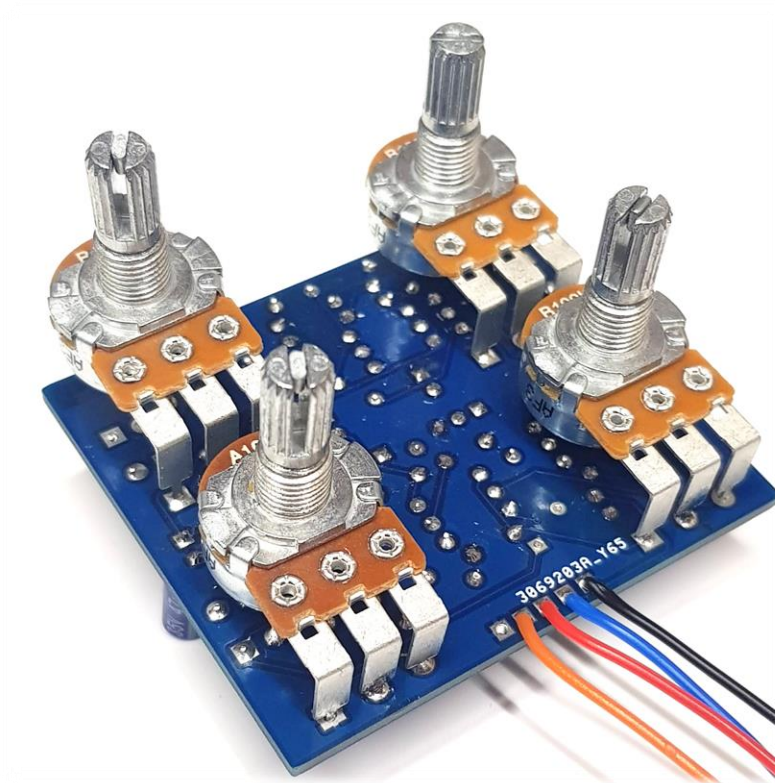

The pots connect to the PCB like this, by this stage you should have soldered the various other components - resistors, diode, transistors and capacitors etc to the board. Check your soldering over before moving forwards.

Now connect the pot as shown above.

### Hooking up the Jacks

This kit comes with mono jacks. Either mounted at the top or the side of the case.

#### Side Mounted

They have two connections, a positive AKA the tip connection. And a negative AKA the sleeve connection.

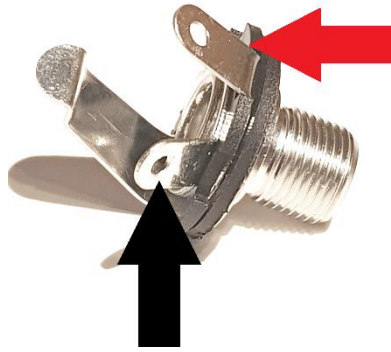

Using this picture as a reference the lug to the right with the red arrow coming from it is the positive/tip wire.

The black arrow is therefore the negative/sleeve wire. This is essentially a ground point.

Connect a long black wire to each sleeve lug.

Connect a further long wire to each tip lug. Do not use red. Use two individual colours, one for each tip.

The wires need to be long enough to go from one end of your pedal to the other as they eventually connect to the footswitch.

Once you have soldered two wires to each of your jacks, put them to one side.

When you eventually put them in place inside the enclosure, they will ground it, people often ask if they need to ground the case with a wire. The answer to that is no.

#### Top Mounted Jacks

This kit comes drilled for top mounted jacks.

The mini jacks look like this. They have soldering lugs to the sides, like little wings.



As you look at the jack in the photograph, the sleeve/ground tab is at the top, and the Tip/posi tab at the bottom.

I suggest that you position the TIP lug into the enclosure, and the sleeve can point towards the base, if the sleeve lug touches the case it does not matter but you may have to bend it inwards slightly to enable the lid to close.



## Power Socket

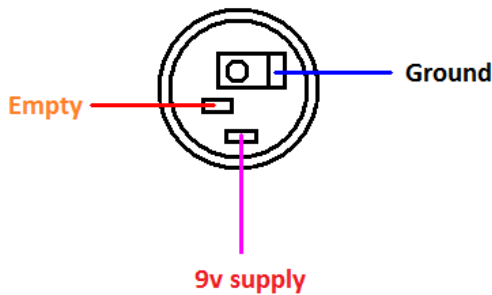

The black wire is the ground point.

The red wire is the 9V supply

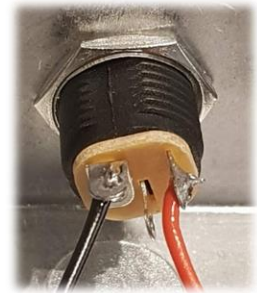

The above is for centre negative power supplies. Should you have the opposite you must reverse the connections.

At this stage, connect two long wires to the socket as shown and set it aside.

There is no need to put anything in the enclosure just yet.

## Test your PCB

This is an important stage, not to be skipped. The PCB connections I use are generic across all my PCB's, so this is relevant for all the kits regardless of the board in the image.

By now, you should have a PCB with its components fitted and its pots soldered. You should also have both jacks and a power socket set a side, all 3 with wires coming from them but going nowhere.

First point of note is don't put anything in the enclosure yet. I see people building inside a tiny enclosure and I always wonder why. Some PCB's are tight enough as it is without reducing your workspace to 6cm wide!

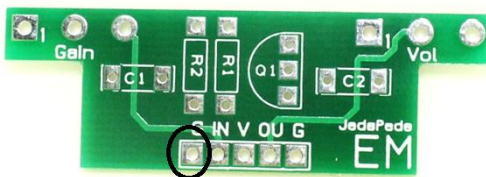

Now get another black wire and solder it to the pcb here.

Once that wire is in place take all 4 black wire ends and solder them together using this technique shown in the next image.

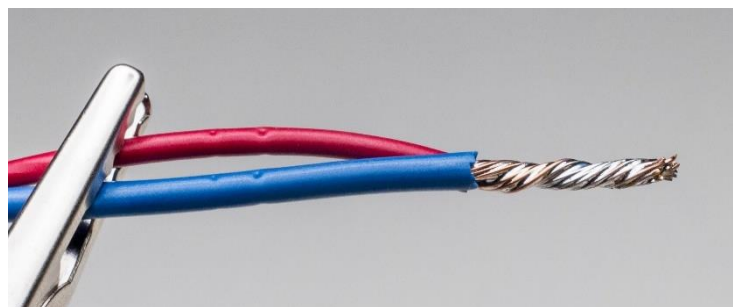

All 4 black wires are now joined. This is your ground network.

Now take the RED wire from the power socket. Solder it directly to the PCB here.



So now you have 5 wires connected, 4 are grounds and the red one taking 9V to the circuit. That leaves two wires, the jack tips.

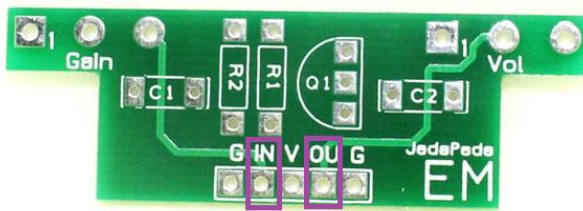

Take one wire from one tip and solder it to the IN pad. This is now your test phase input jack.

Take the final tip wire and solder it to the OU pad. This is now your test phase output jack.

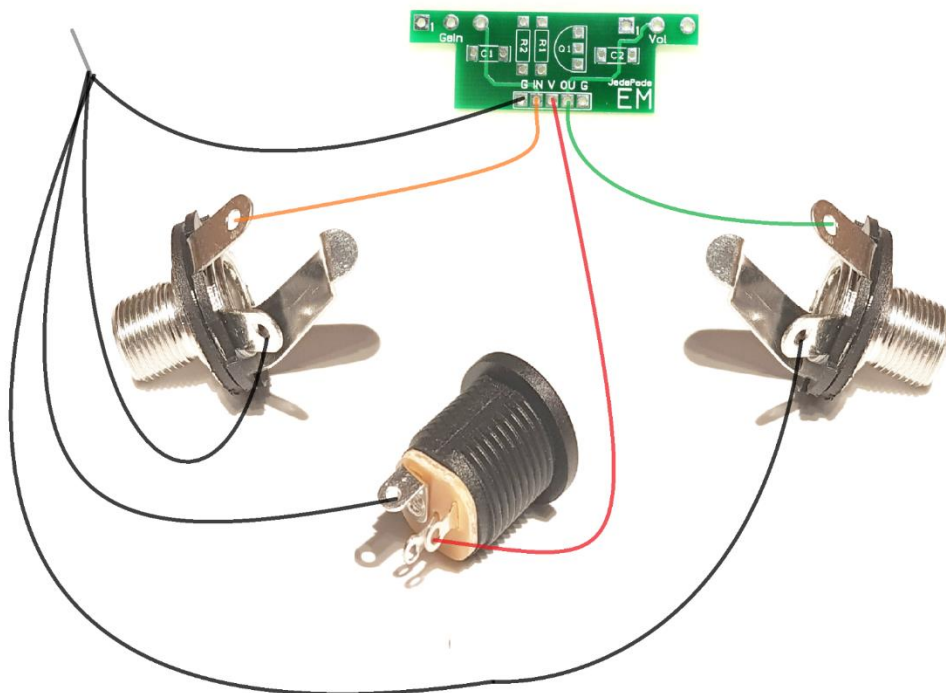

It should look just like this

The next thing to do is to plug it in. Hopefully its obvious that it needs some power and a decent power supply is what is called for, the cheap £6.99 ones are not good.

Guitar (or whatever you play) goes to the input jack and then the output jack goes to your amp. Set the controls to half way up and.... Play.

Hopefully its alive and kicking. If it's not working, then you need to find out why. Do not continue beyond this point until you get it working. Adding a footswitch will not magically make a circuit work. Troubleshooting is a necessary evil at times.

The best advice now is to have a quick break. Fresh eyes spot faults an excited mind missed! Once you have had a break take some good quality photos and upload them to the [forum](#) for some peer support.

If your PCB is working you are ready to connect the board to the footswitch! Follow the next stages meticulously and all being well by the end of it you will have a lovely finished pedal!

The next step involves undoing the tip wires from the PCB as they will now move to the 3PDT. It is a couple of steps backwards I am afraid, but nothing to arduous.

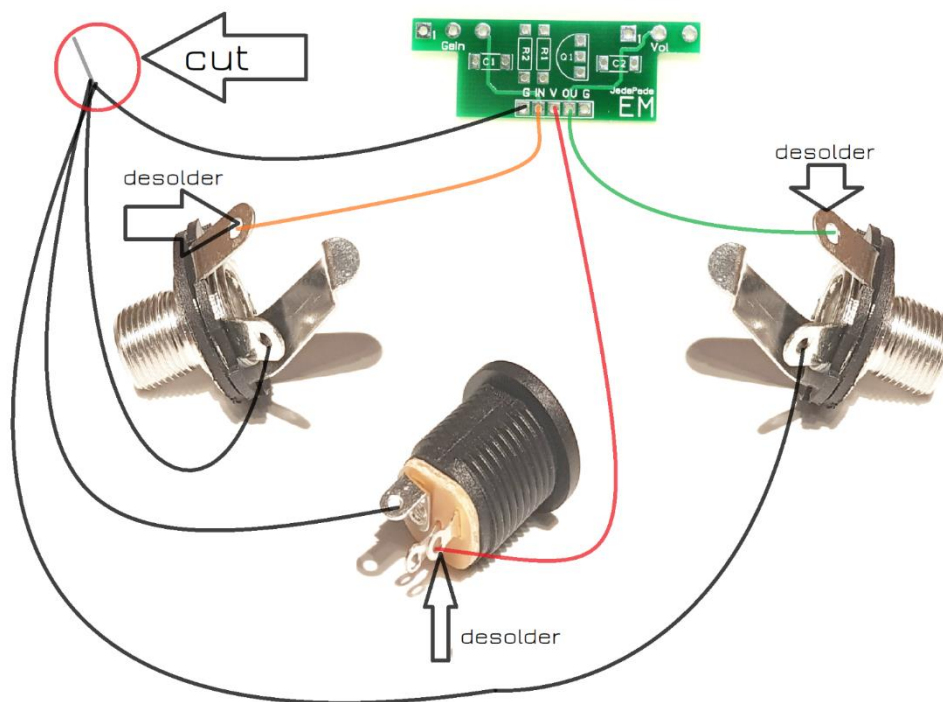

Once you have de-soldered the three wires, clean the joints up and re solder fresh wires. About 2 inches long will be perfect, a little longer if you wish. They will be cut to length later.

Cut the ground joint and strip the ends of all wires again so they are fresh.

The PCB should have 4 wires coming from it all about 5/6 inches long.

## The Footswitch.

Have a look at the footswitch. It has 9 pins. The orientation of the switch is crucial. If you do it wrong your switch will not work, you might ruin it and you will certainly have to un do it.

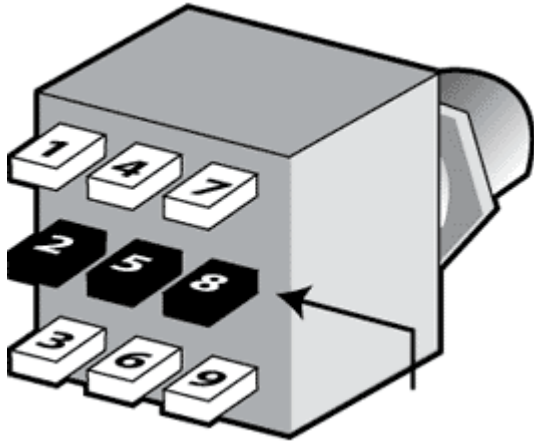

The pins on the switch must run left to right like this, so the top row of pins would be 1, 4, and 7.

If you put it in with 1, 2, and 3 across the top row you are wrong.

In reality there is no 'pin 1', it's just used here as a reference. So, if you turn it 180 degrees, pin 9 could also be pin 1. The switch will still work providing the lugs are horizontal.

There are various ways to connect a switch to a circuit. Most people think you get a 'true bypass' switch. It's just a method of wiring. A switch is merely a switch.

There are two ways you can connect the switch. One uses a PCB and one involves manual wiring.

I have designed a PCB specifically for the footswitch and whilst over time the layout of the switch may change slightly, the mechanics of it do not. In its simplest form, it solders to the switch and the wires solder to its pads.



The two fit together like this. Take some time to study the footswitch and PCB.

**NOTE:** the lugs run from left to right as I said above.

The PCB has two sides, it must go on like this. The other side looks quite different and does not say 'jeds peds' on it.

Once you are satisfied it is on the right way then it must be soldered into place, **but** don't do it yet as I want to explain a second method of switch wiring that you may decide suits you better.

The other way you could hook up the footswitch would involve manual wiring. This is a method that can be used on any pedal. The following image gives a good visual representation of how to hook up the entire pedal, albeit in a different enclosure.

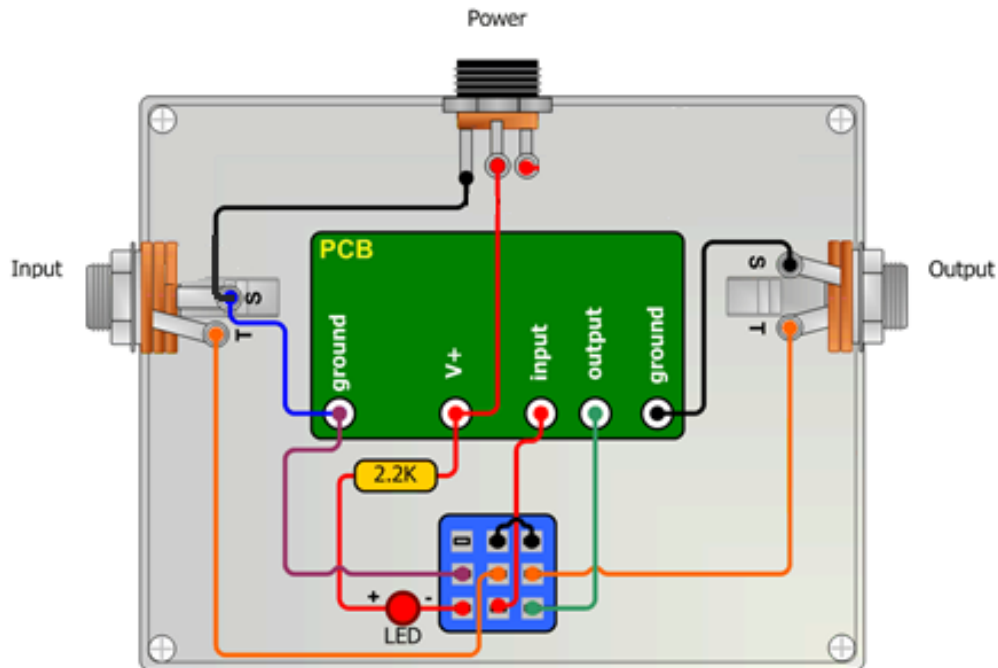

To compare this to the earlier 3PDT image that had numbers on the pins, you would have this...

- Pin 1 – Empty
- Pin 2 – Ground
- Pin 3 – LED
- Pin 4 – Pin 7
- Pin 5 – Input Jack tip
- Pin 6 – PCB Input
- Pin 7 – Pin 4
- Pin 8 – Output Jack Tip
- Pin 9 – PCB Output

**Please make sure you get the switch lugs the correct way!**

There are loads of other ways to wire up a foot switch, the two ways I suggest are simple and effective.

A CLR is a current limiting resistor. It reduces the voltage hitting the LED. On this picture the CLR is shown as 2k2. We supply 4k7 but you can use any value up to around 10k.

Just like we did at the test phase all your ground points must connect, there are usually 5.

- The main PCB has a ground plane and a couple of pads marked G. You can use both, or just one.
- The power supply has a ground lug, you should have a black wire on it from earlier.
- Both jacks have a sleeve which needs to connect to ground.
- The footswitch has a ground lug.

The same goes for all V pads. V is the direct power feed. So you must connect power to the CLR and to the V pad on the main PCB

If you want to use this method, and wire it all manually, then you can start to box up your circuit as its easier and neater to finish this off inside the enclosure so you can snip your wires to length. Take your time and think each stage through methodically.

Cut your wires to length before you solder them, remember check twice, cut once, solder once.

### Using the Foot Switch and its PCB



Whilst its completely your own choice which method you use, I do suggest this as it is neater and less confusing.

The PCB is double sided, and here are pictures of both sides.

Side 1

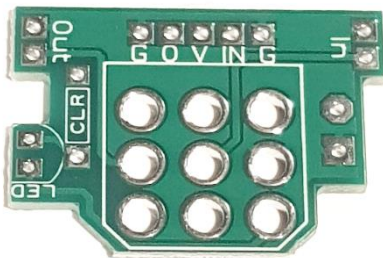

Side 2

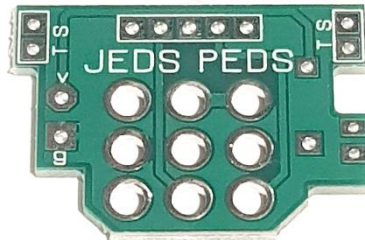

Eventually side two will face out of the enclosure.

Here is an overview of the connections on the PCB.

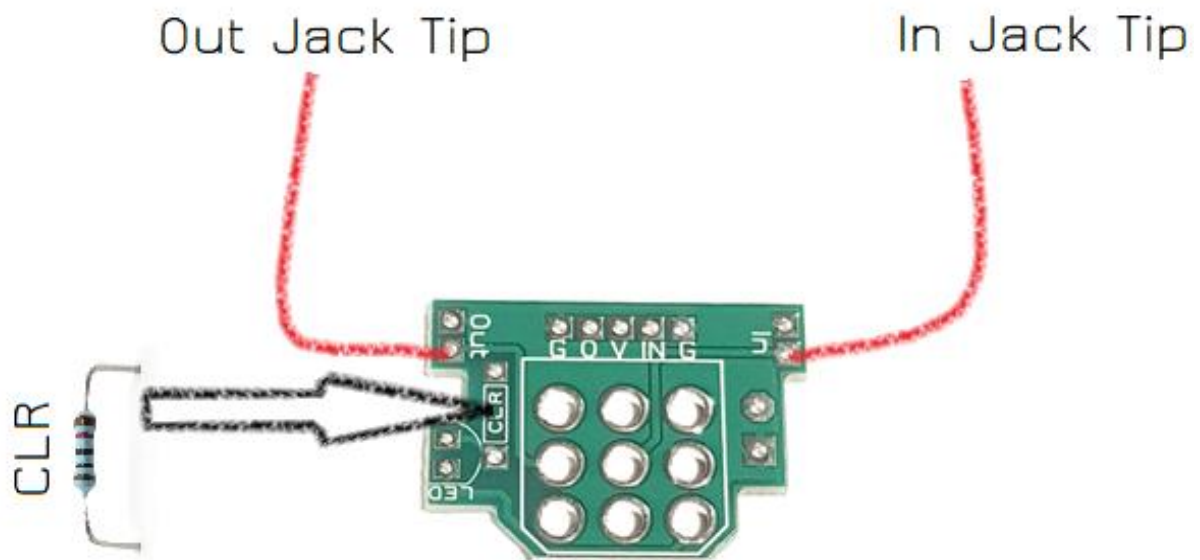
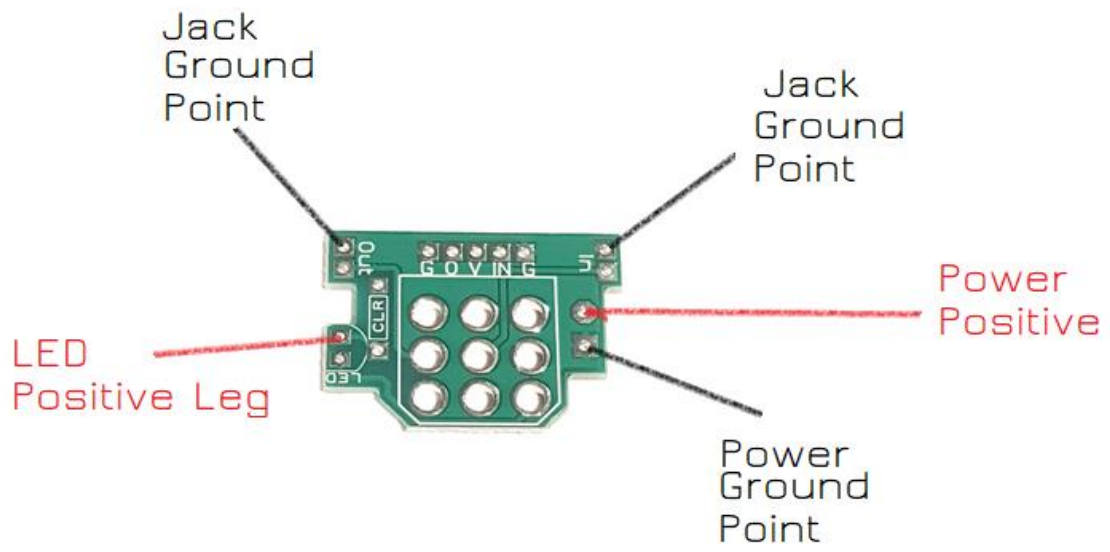

This is the side of the PCB that the switch sits.

It needs soldering into position.

The lugs MUST face side to side as shown below.

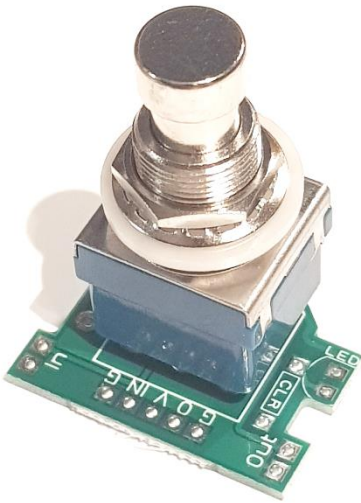

The final connections are between the two boards.

To give you an idea about this I have shown the connections for the G and V.

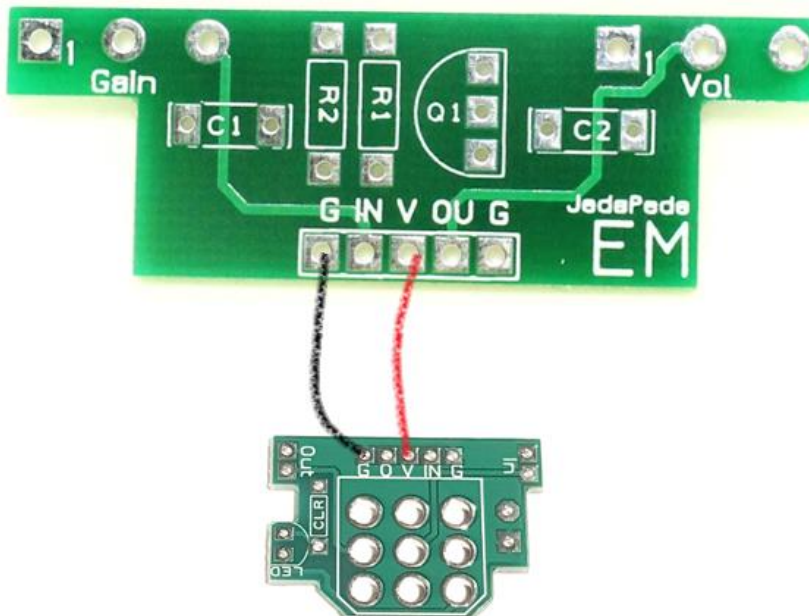

The IN pads also require a connection, as does the OU.

You should have 4 wires running between the two PCBs.



Start working through these connections by mounting the main pcb inside the enclosure as well as the other offboard components. Then one by one make the appropriate connections ensuring you use appropriate wire lengths. You do not want a rats nest.

Once all connections are complete you should have a pedal to test!

If it does not work and you can't spot an error, don't forget we have the [Facebook forum](#) to guide you.

Good Luck and happy soldering 😊

*Love Jed x*

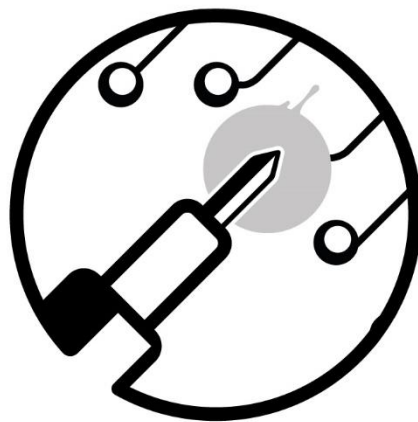

# JEDS PEDS